

**TANQUE SÉPTICO
PLANTA BAIXA - ESC. 1:25**

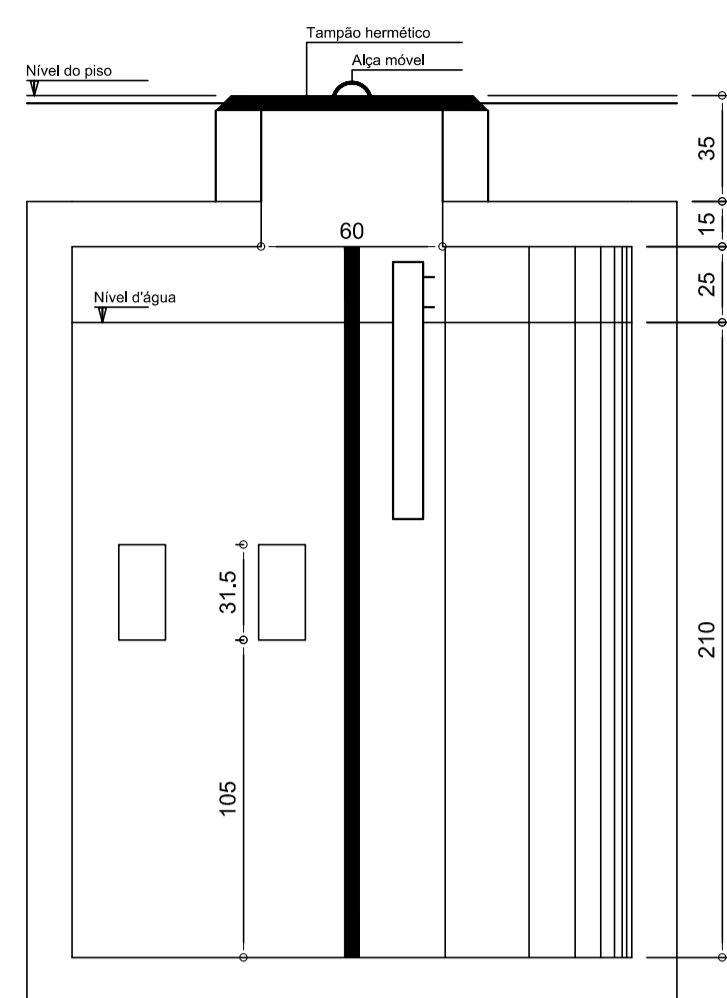

**TANQUE SÉPTICO
CORTE - ESC. 1:25**

| Legenda Detalhada | | Legenda | |
|-------------------|----------------|---------|----------------|
| | Caixa Sifonada | | Caixa Sifonada |
| | Caixa Sifonada | | Caixa Sifonada |
| | Caixa Sifonada | | Caixa Sifonada |

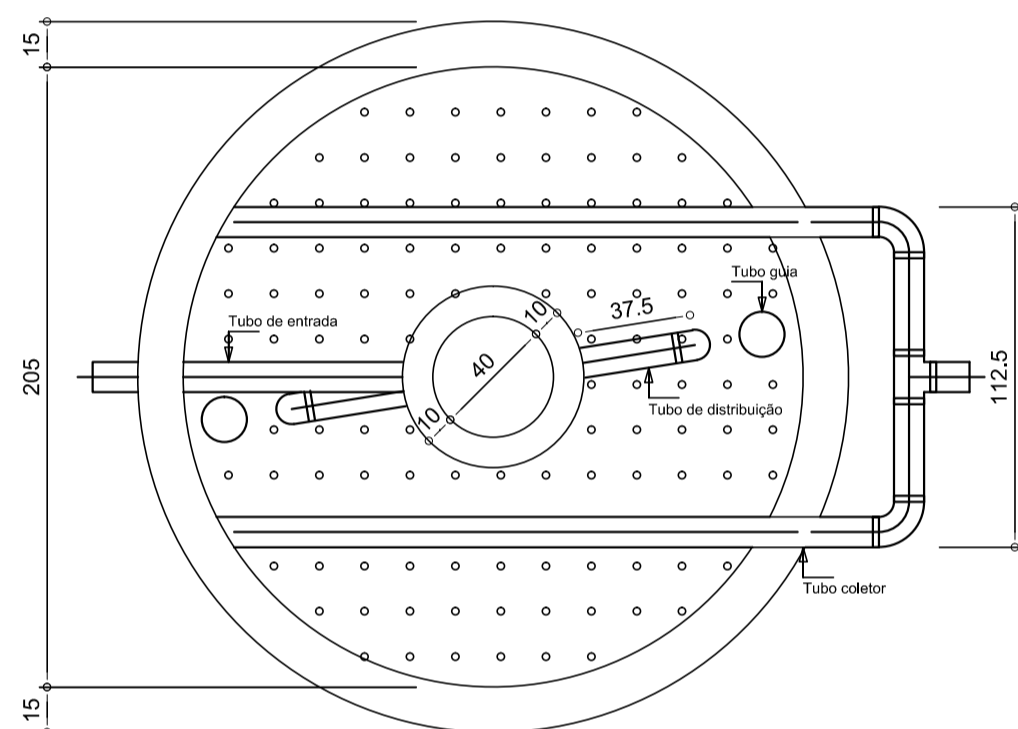

**FILTRO ANAERÓBIO
PLANTA BAIXA - ESC. 1:25**

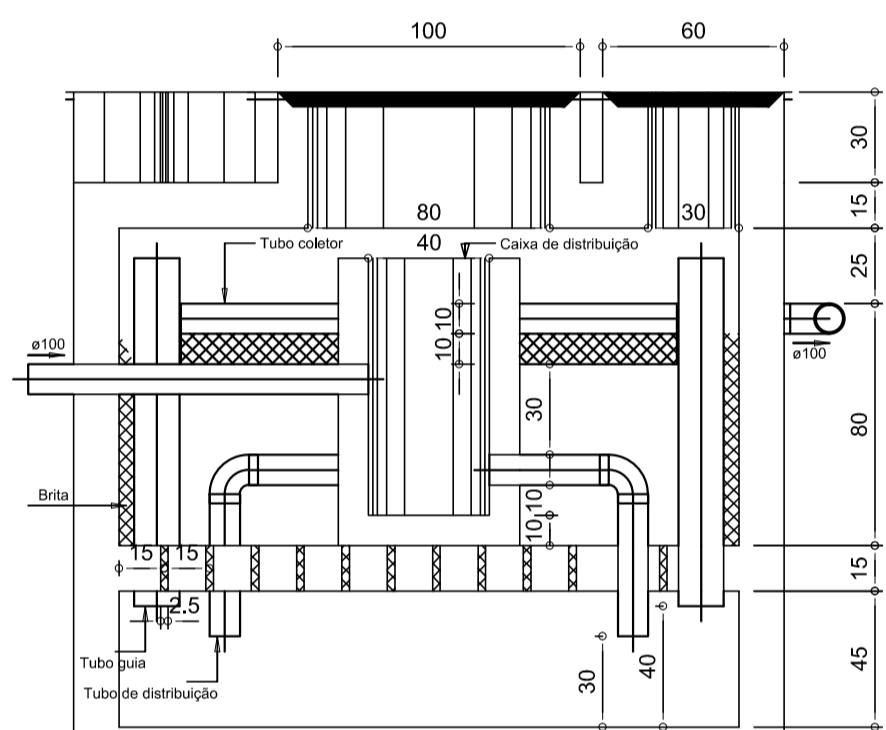

**FILTRO ANAERÓBIO
CORTE - ESC. 1:25**

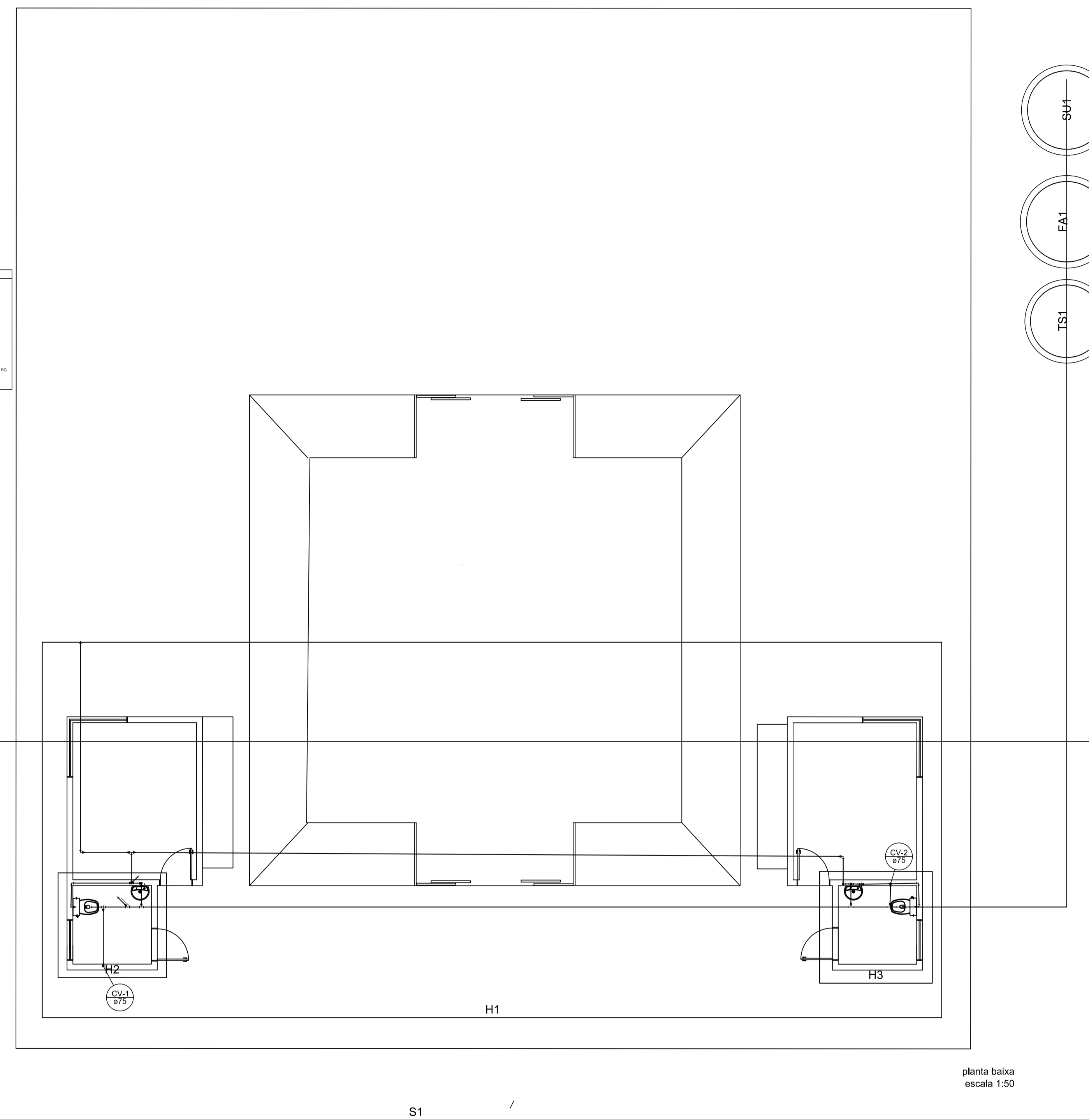

PLANTA BAIXA- ESC 1/50

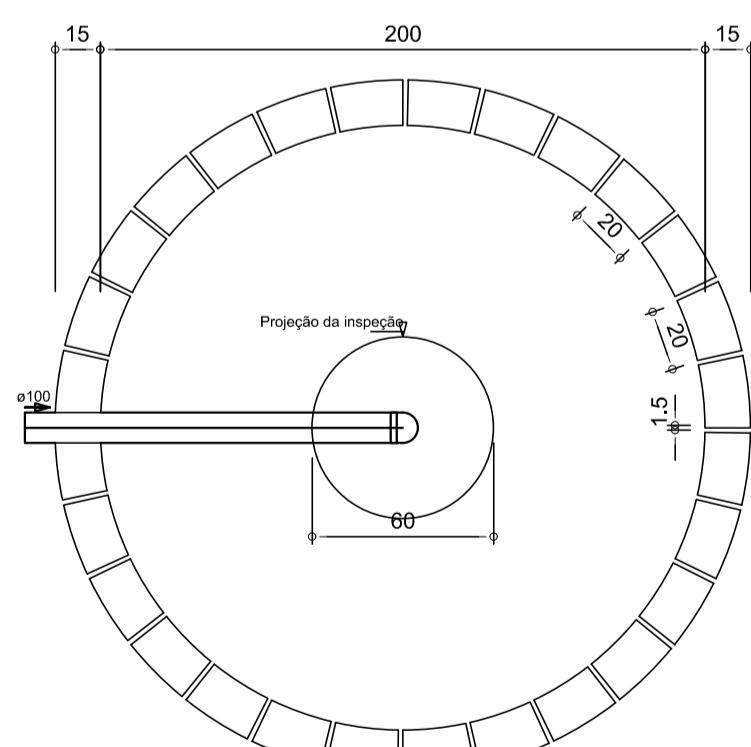

**SUMIDOURO
PLANTA BAIXA - ESC. 1:25**

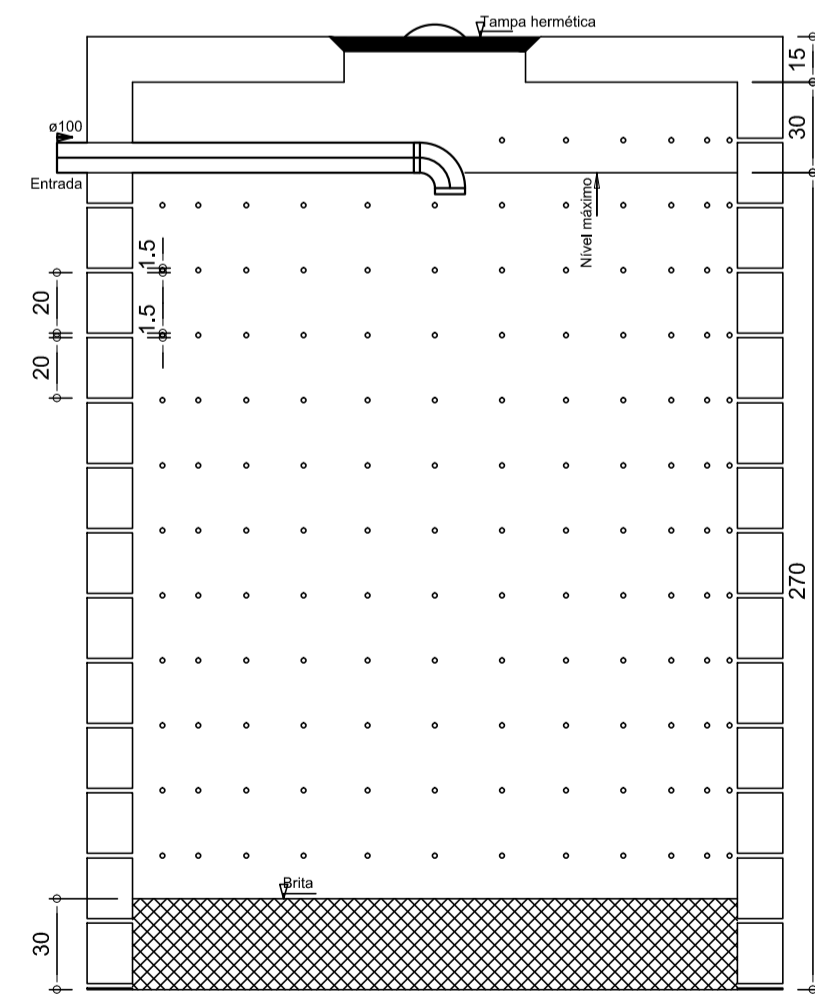

**SUMIDOURO
CORTE - ESC. 1:25**

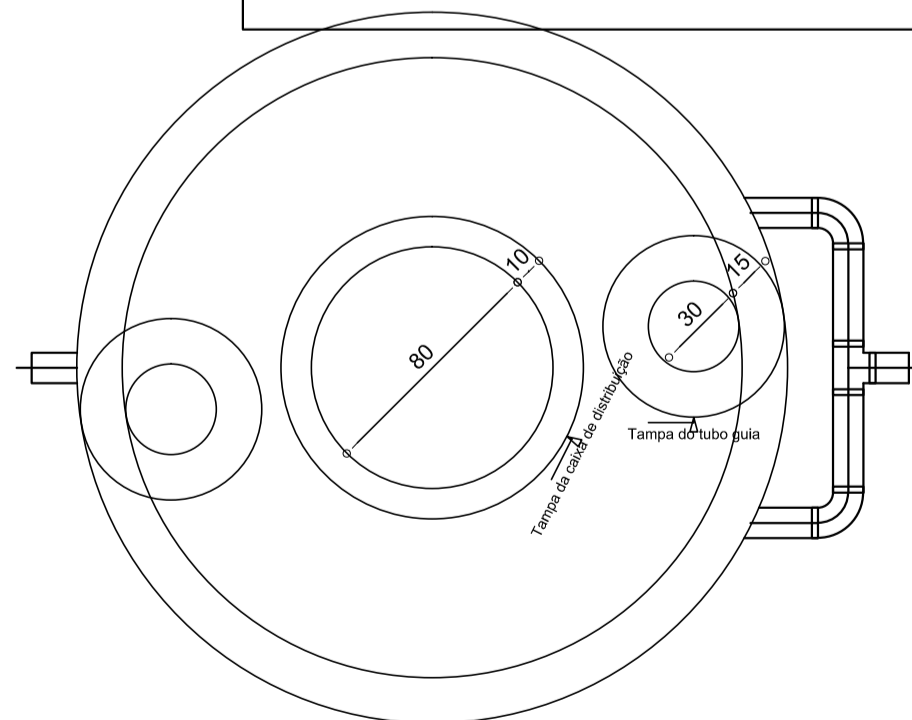

**FILTRO ANAERÓBIO
PLANTA BAIXA - ESC. 1:25**

SU1
FA1
TS1

**ESTADO DE SANTA CATARINA
PREFEITURA MUNICIPAL DE SÃO CRISTÓVÃO DO SUL
SECRETARIA DE PLANEJ. - DEPARTAMENTO DE ENGENHARIA**

Projeto: ACADEMIA DA SAUDE - PROJETO HIDROSANITARIO

Planta: PLANTA BAIXA E DETALHES

| | | |
|---|---|--|
| <p>Projeto: ACADEMIA DA SAUDE - PROJETO HIDROSANITARIO</p> | <p>Planta: PLANTA BAIXA E DETALHES</p> | <p>Prancha: 1/2</p> |
| <p>Eng. Ciro Fontana Sordi - CREA/SC 063545-0 email: engenheiroc@brtur.com</p> | <p>Rua Braun</p> | <p>Prefeito: Jaime Cezca email: pmrsc@pmrsc.sc.gov.br</p> |
| <p>Escala: INDICADA</p> | <p>Unidade: m</p> | <p>Data: 25-04-2012</p> |